

Date _____
 AVFI Sales REP _____
 Customer Signature _____

Quote No. _____
 Customer No. _____
 AVFI No. _____

Office Use Only

To generate your order form, please refer to the information provided below to insert the alphabetic and/or numeric code in the respective category boxes. Please note that without this filled out Order Form, your purchase **cannot** be processed.





1	2	3	4
DS3048-LFT			

1 Product Model











2 Choose Product Finish

Standard Finishes (Ships within 1-15 business days)

			
Code FMT (Fusion Maple)	Code BRT (Baroque)	Code ART (Aria)	Code EBT (Ebony)

Optional Finishes (Ships within 20 business days)

							
RCT	HCT	CLT	CJT	ELT	CWT	BAT	SGT

- 3 Chargeable Accessories (Check all that apply)**
- Code **OO** No Accessories
 - * Code **EF** **CHGQIB** Wireless Charging Station Black..... Qty _____
 - Code **K1** **C900S** Single Monitor Arm..... Qty _____
 - Code **K2** **C900D** Dual Monitor Arm Qty _____
 - Code **P2** **PCH730** PC Holder..... Qty _____
 - * Code **K3** **PLM1022** LCD Monitor Mount..... Qty _____
 - * Code **D3** **FM3** Countdown Timer and Clock..... Qty _____
 - * Code **D2** **LIGHT-18** Adjustable Gooseneck Light..... Qty _____
 - * Code **E3** **CUB3** Round Cable Well..... Qty _____
 - * Code **EB** **CUB4** Dual AC+USB Power Panel Qty _____
 - * Code **EJ** **CUB22** Black 3 Module Panel..... Qty _____
 - * Code **EK** **CUBM3** 3 Module Power & Data Panel..... Qty _____
 - * Code **EL** **CUBM4** 4 Module Power & Data Panel..... Qty _____
 - * Code **D1** **MIC-18** Gooseneck Microphone Qty _____
 - Code **P10** **50-CAS** Easy Maneuvering Casters Qty _____

Comments (Please use this section to provide additional information)

* **Cutout Required (Extra Charges will apply)**

Notes

CAD Drawings/Symbols
 CAD drawings are available by request at sales@vegroun.net

Custom Cutouts
 Estimated lead time within 20 business days from receipt of P.O. and signed drawings.

Customizations
 Modifications to design such as shape and/or size variations have to be quoted on a per case basis and are applicable for quantities of 10+ only.

Custom Cutout Option on Page 2

Please indicate custom cutout location on the drawing(s) below

4 Custom Cutout Option (Extra charges will apply)

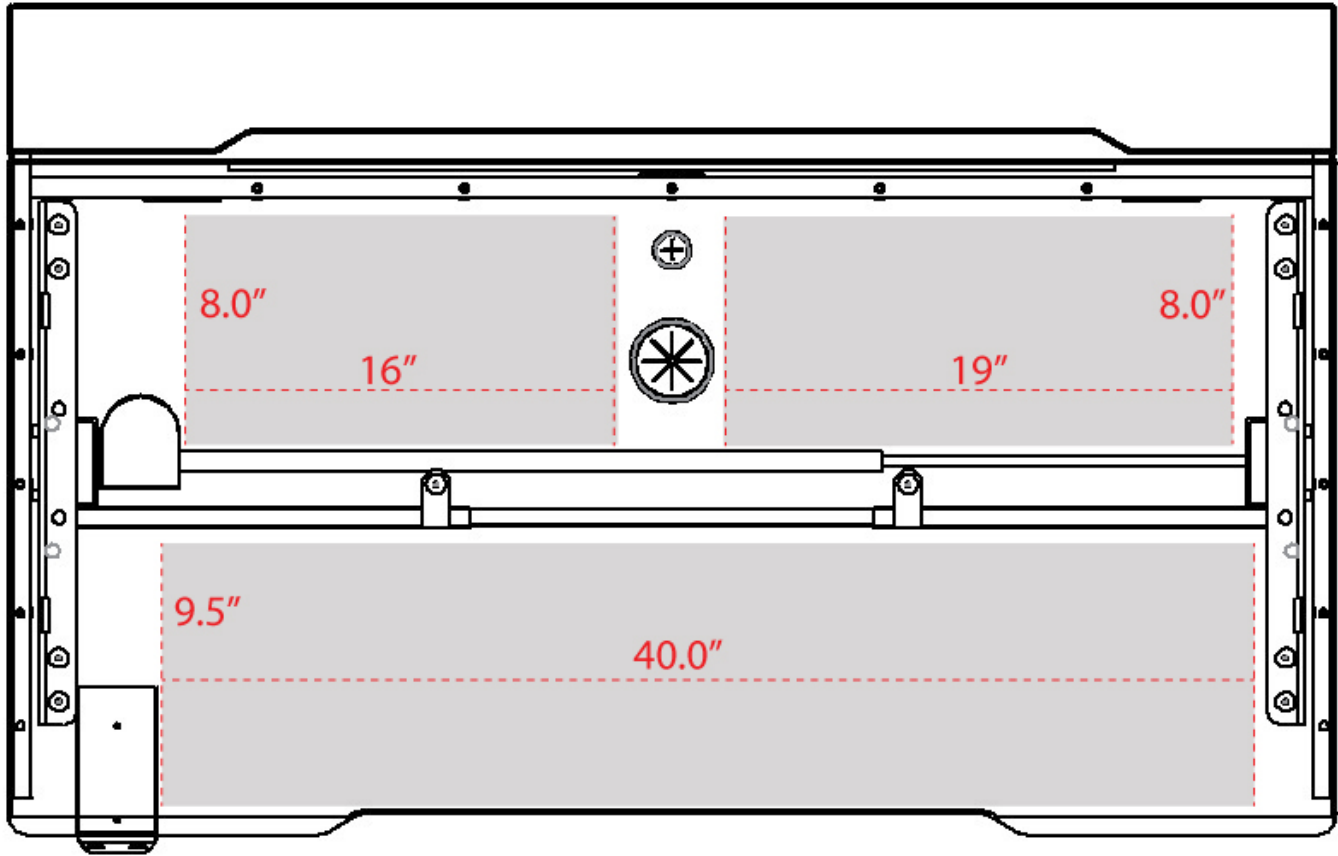

Code **CO** No Custom Cutout

Code **CC** Custom Cutout (Specify on Cutout Area Above)

■ Cutout Area